

Chapa Perfilada FTB 4 fachada

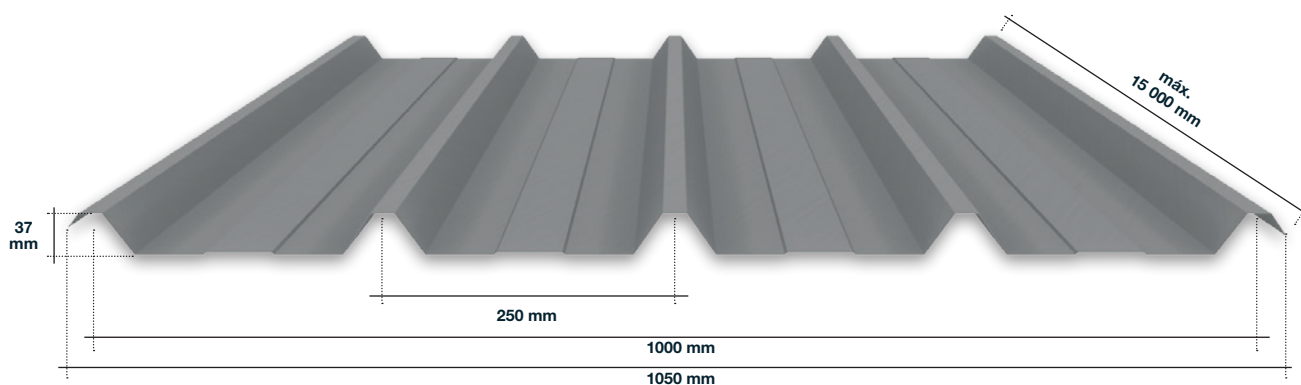

Características:

		STANDARD	SOB CONSULTA	
Qualidade do Aço		S220GD+Z	DX51D+Z, S250GD+Z a S350GD+Z	
Espessura da chapa		0,4 a 0,5 mm	0,6 mm	0,7 mm
Suporte Metálico	Galvanizado	140 a 180 gr/m ²	Até 275 gr/m ²	
	Revestimento	Poliéster (25 µm)	PVDF (25/35 µm)	HDX (55 µm)
Cores		Disponíveis na tabela RAL	Restantes	

Caso pretenda outras características que não constem na(s) tabela(s), por favor contacte o departamento técnico da FTB